

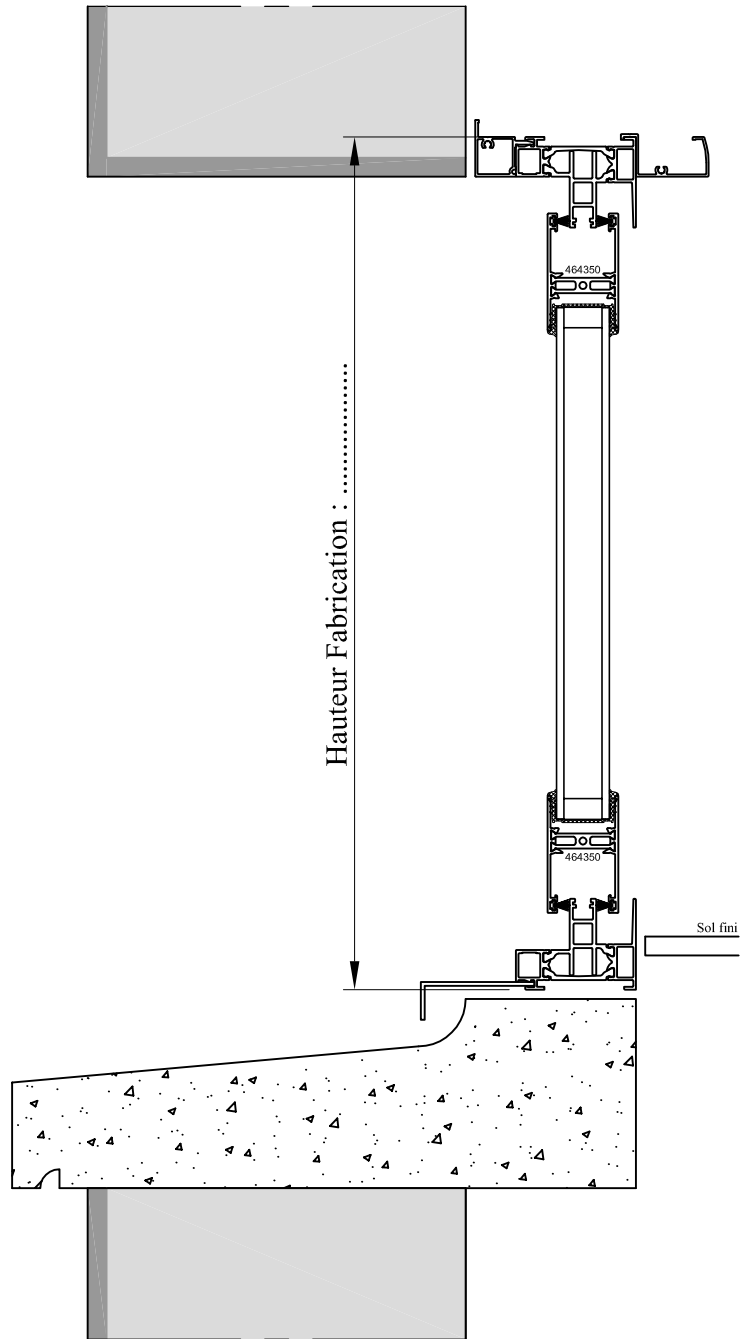

# LANCEMENT

Menuiseries : ALUMINIUM

Gamme : GALANDAGE

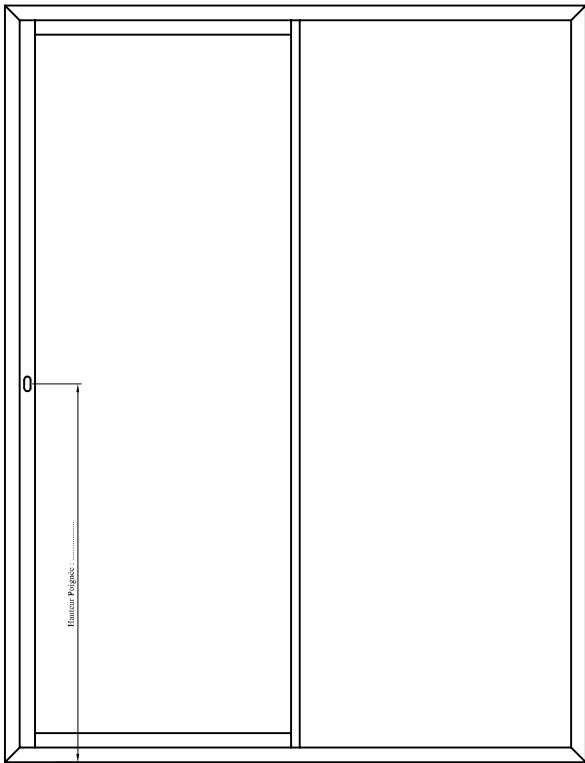

Exemple :  
Dormant 476740

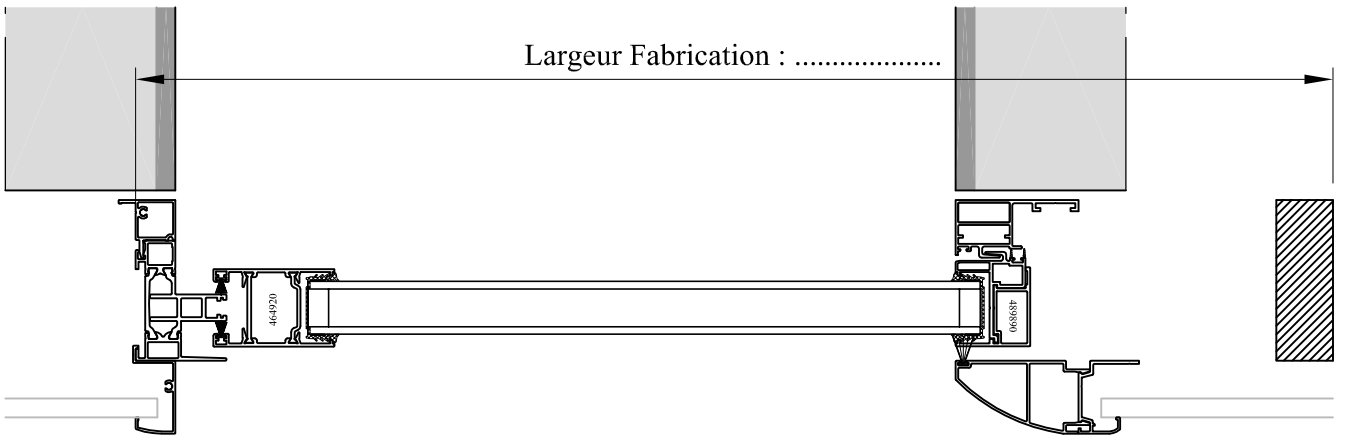

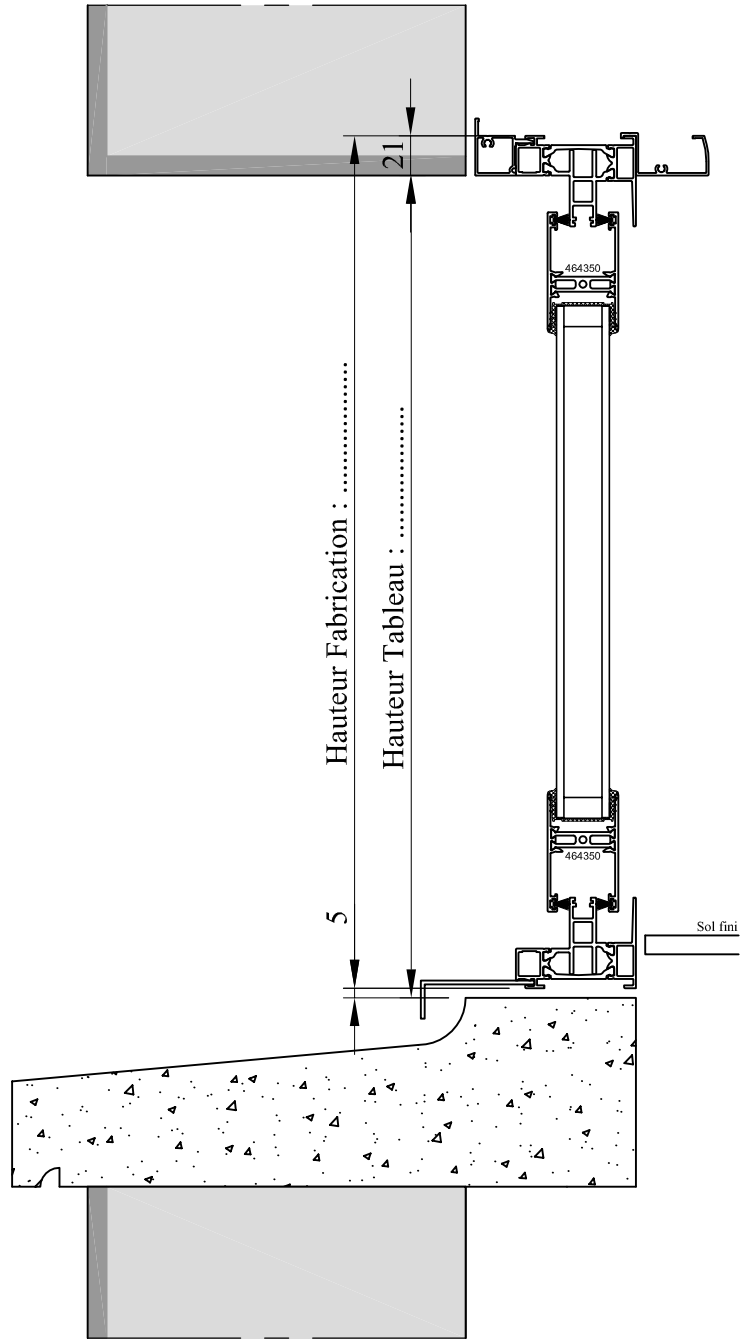
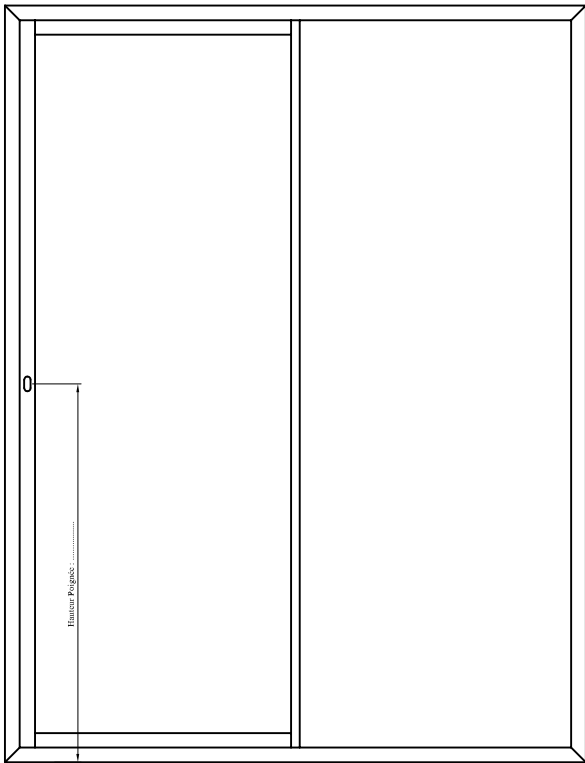

Exemple :  
Dormant 476740

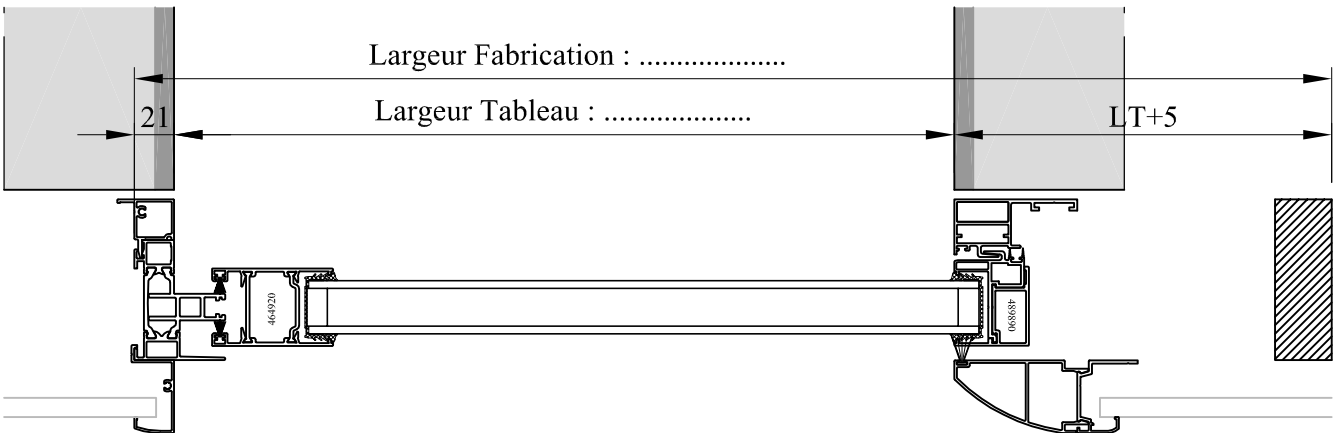

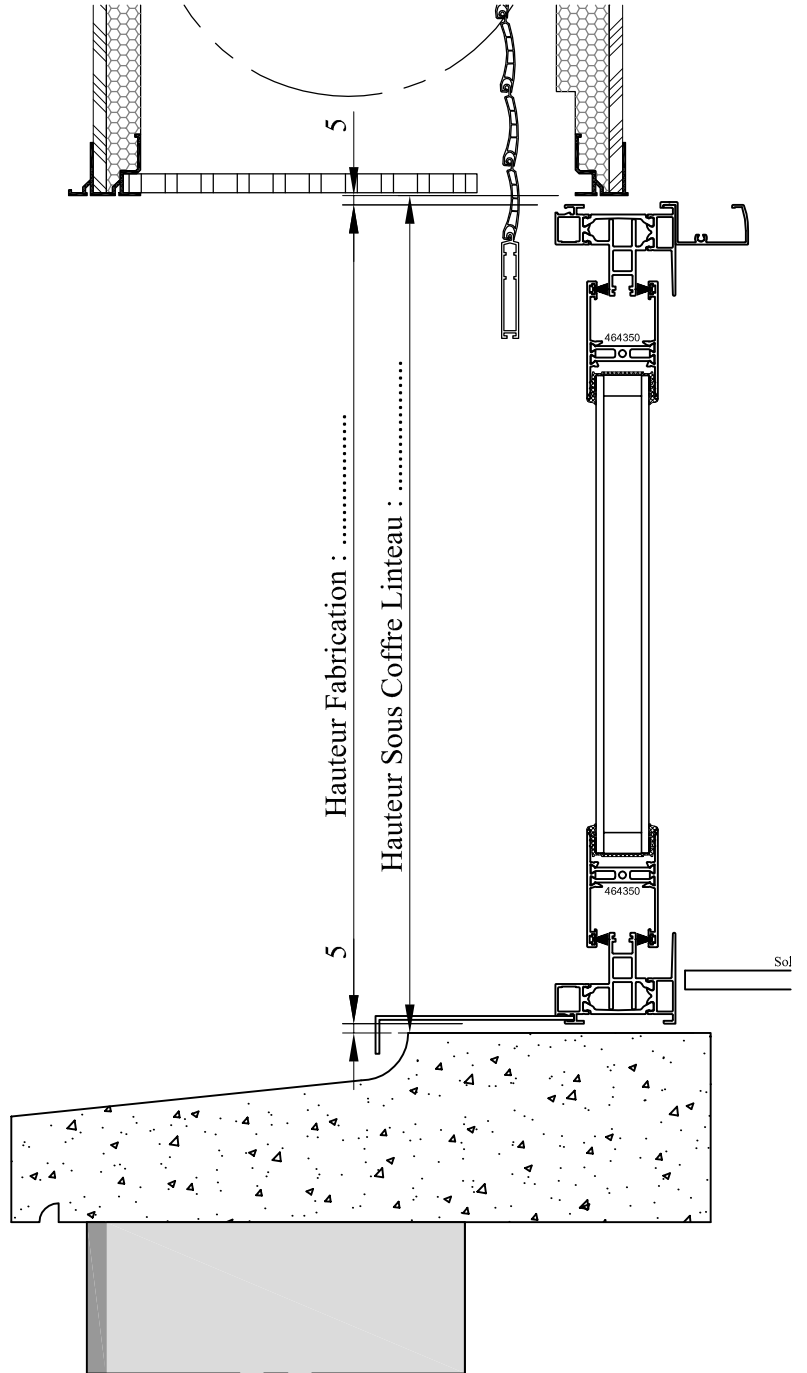
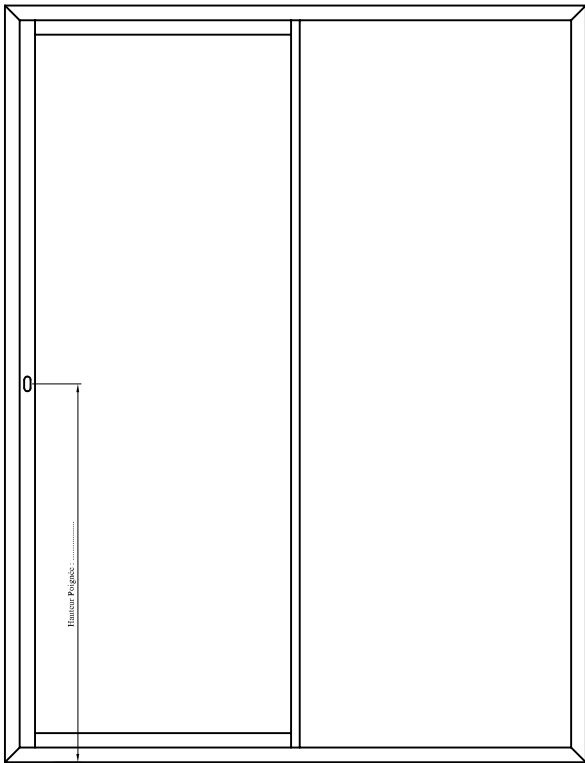

Exemple :  
Dormant 476740

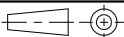
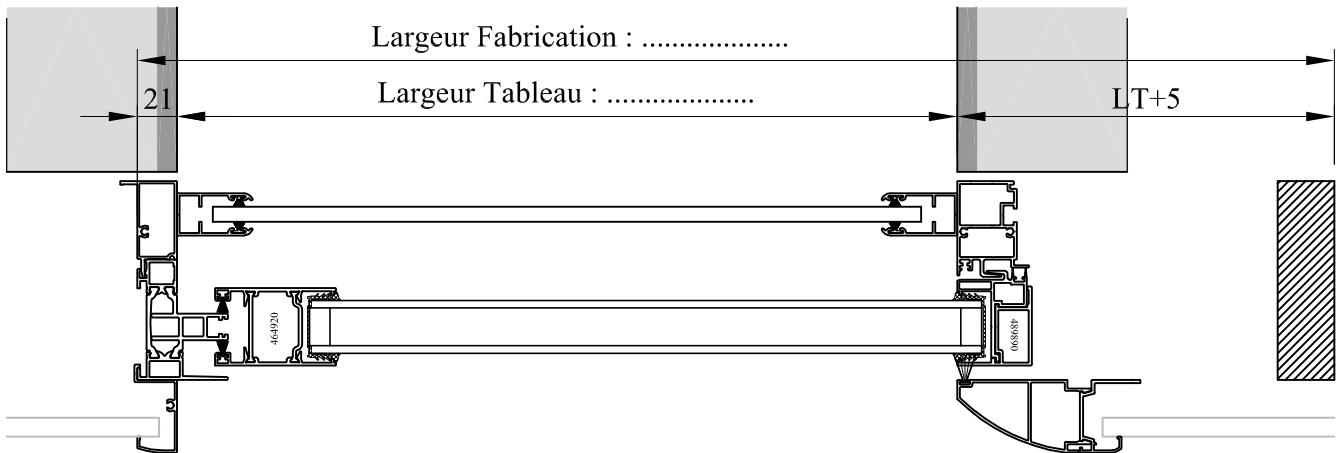



# PROFILES ALUMINIUM

Menuiseries : ALUMINIUM

Gamme : GALANDAGE

## MONTANTS DT MONOBLOC

## DORMANT 1R

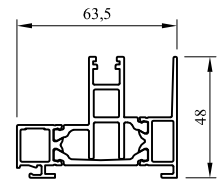
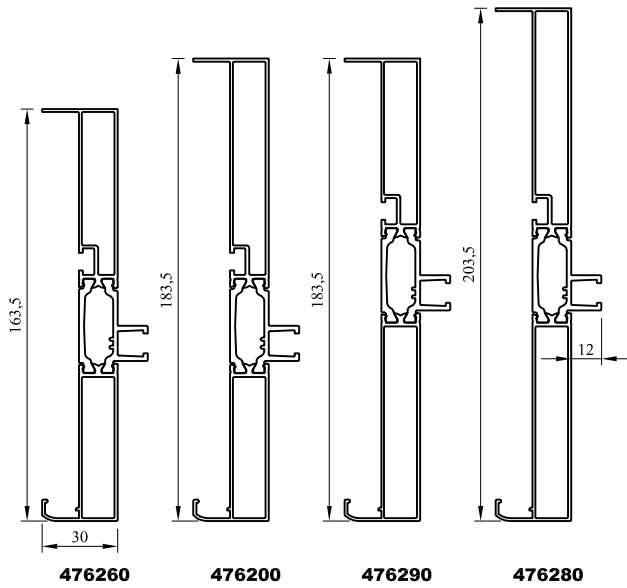

476740

## TAPEES HAUTES

## TRAVERSE HTE DT 2R

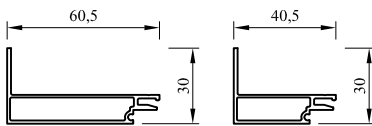

478330

478320

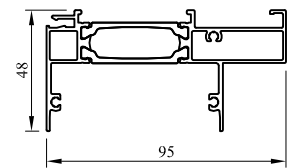

476210

## RECUEIL D'EAU

## APPUI

## TRAVERSES BASSES

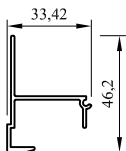

478560

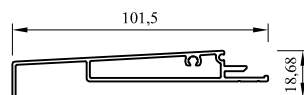

446540

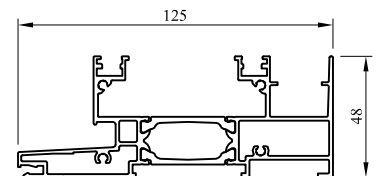

476190

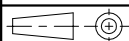

## SUPPORT/ HAB. CLOISON INT.

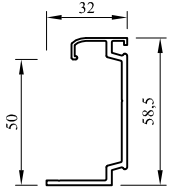

492360

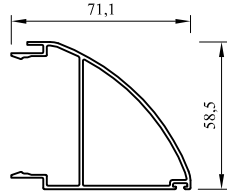

446300

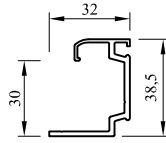

492370

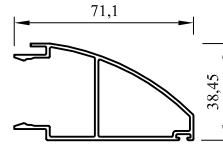

478550

## CHICANES EXTERIEURES

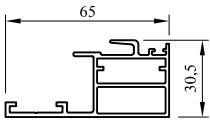

485790

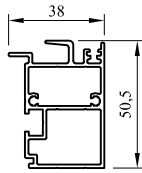

138250

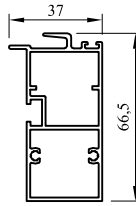

478300

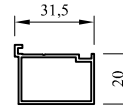

344960

## HABILLAGES INTERIEURS



331490

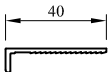

331500

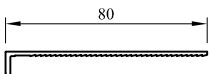

331520

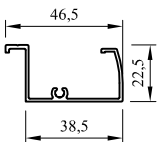

478540

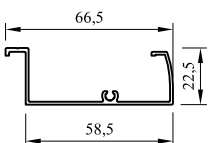

446200

## TAPEES D'ISOLATION

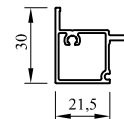

478480

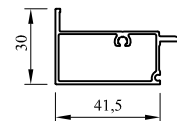

478470

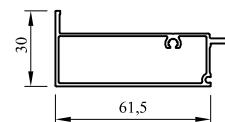

478460

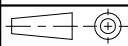

## MONTANTS CHICANE

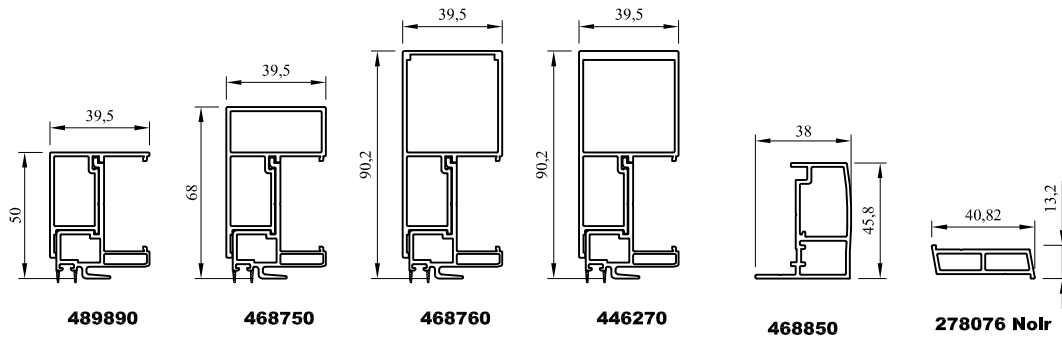

## MONTANTS OUVRANT

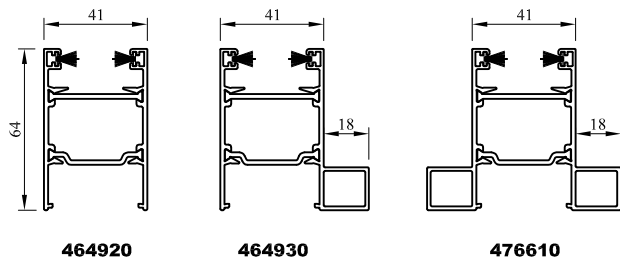

## PROFILS PERCUSSION

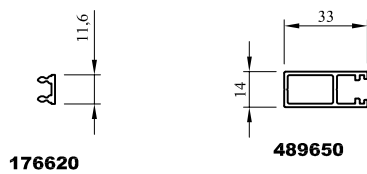

## TRAVERSE OUVRANT

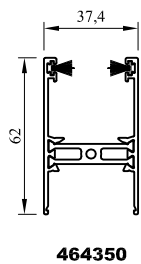

## TRAVERSE INTER. OUV.

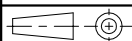
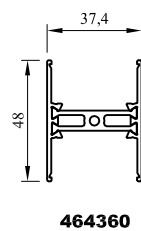





**DETAILS**

**MASSE MENUISERIE**

Menuiseries : ALUMINIUM

Gamme : GALANDAGE

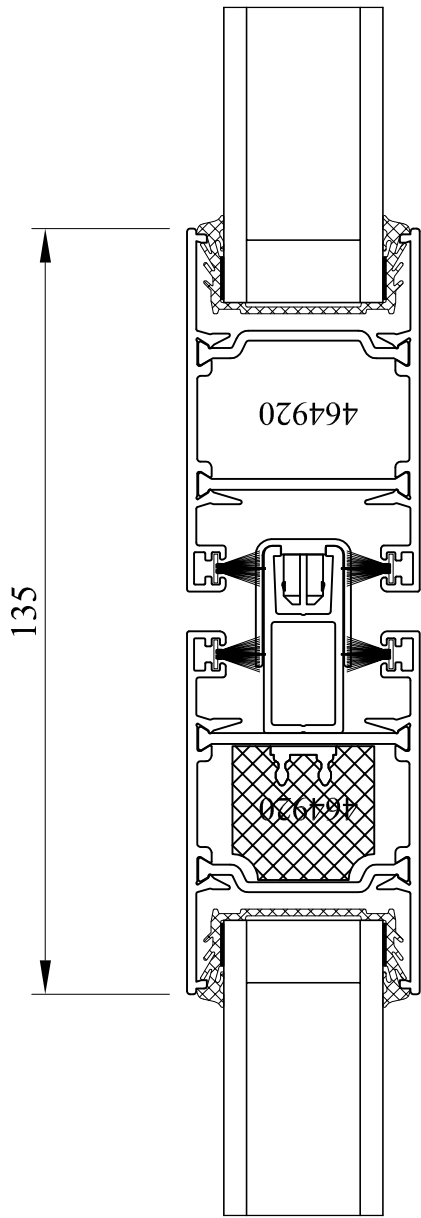

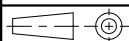
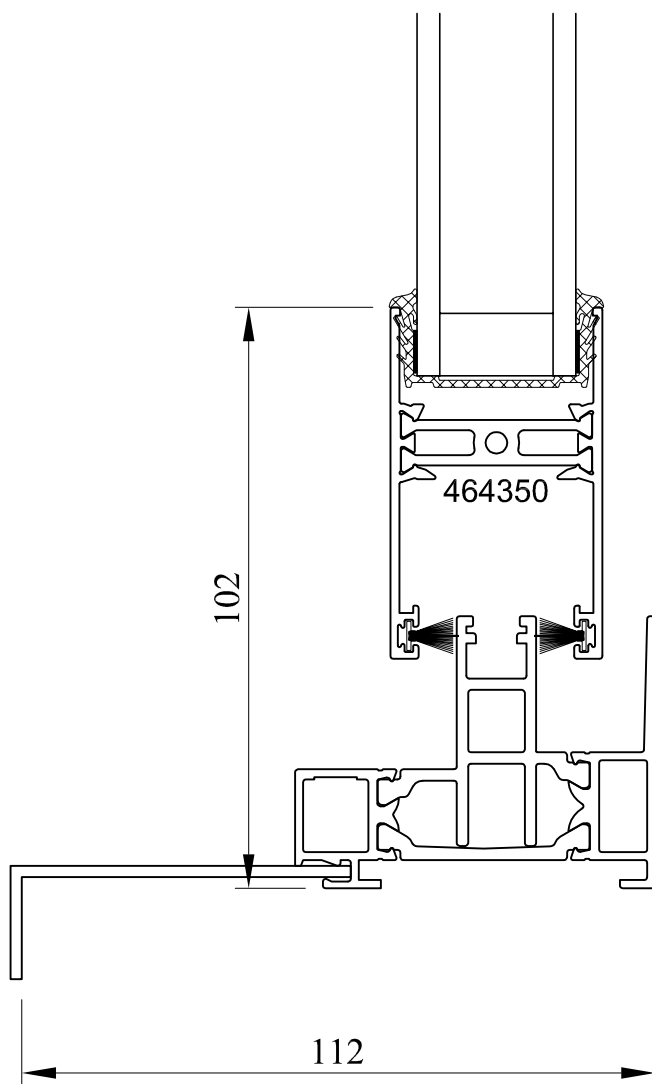

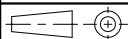
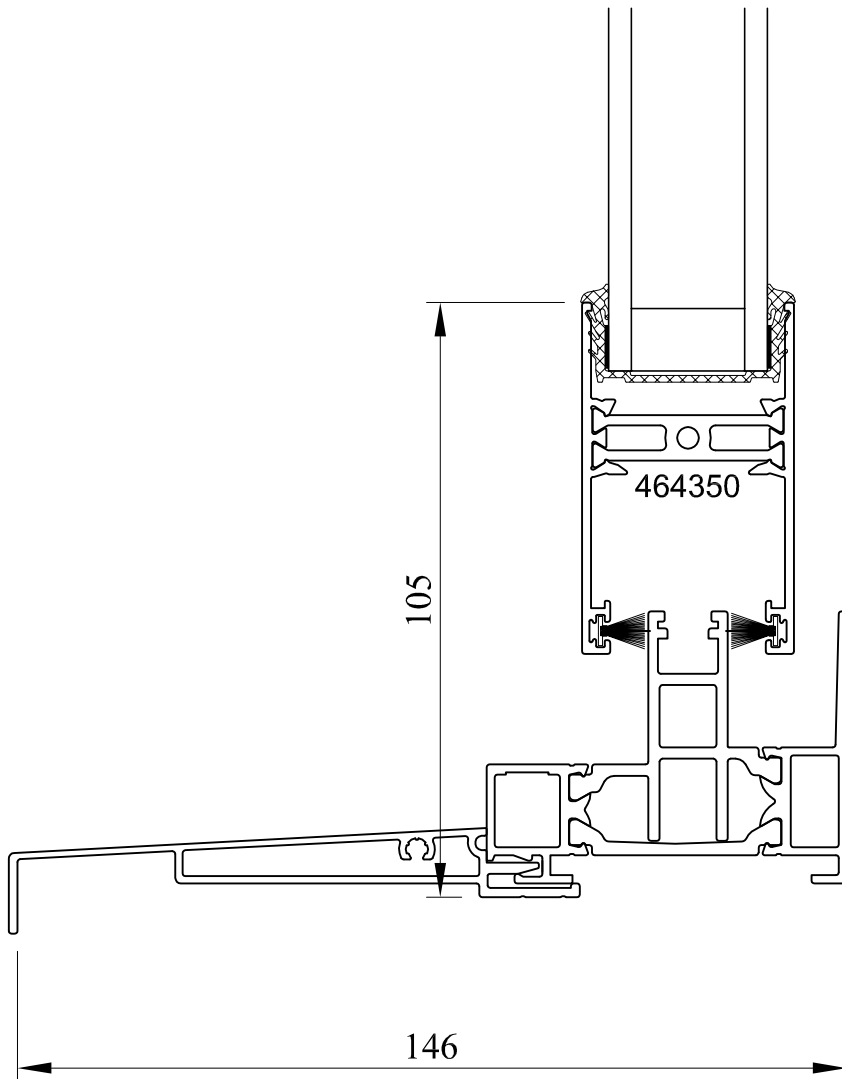

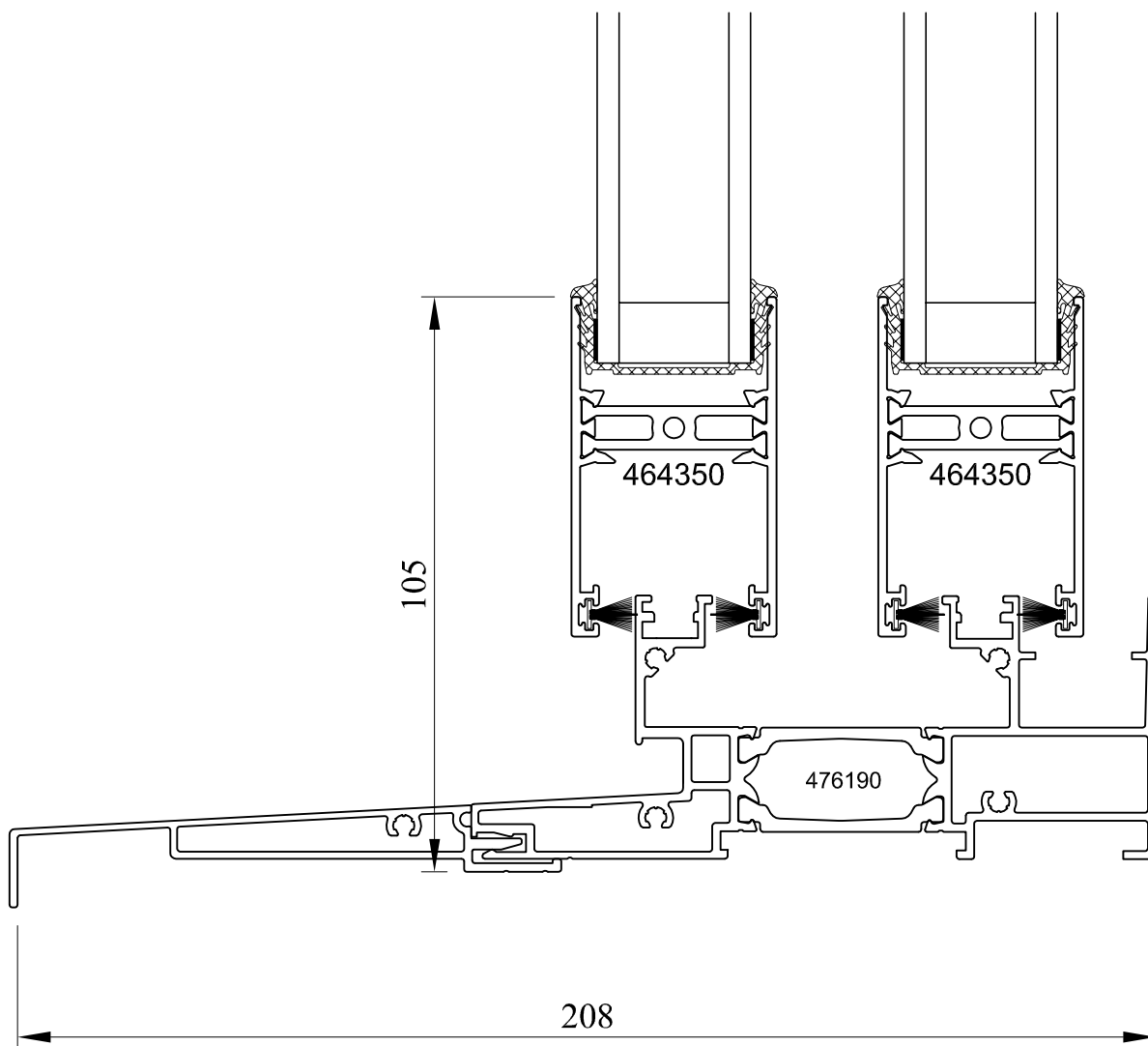

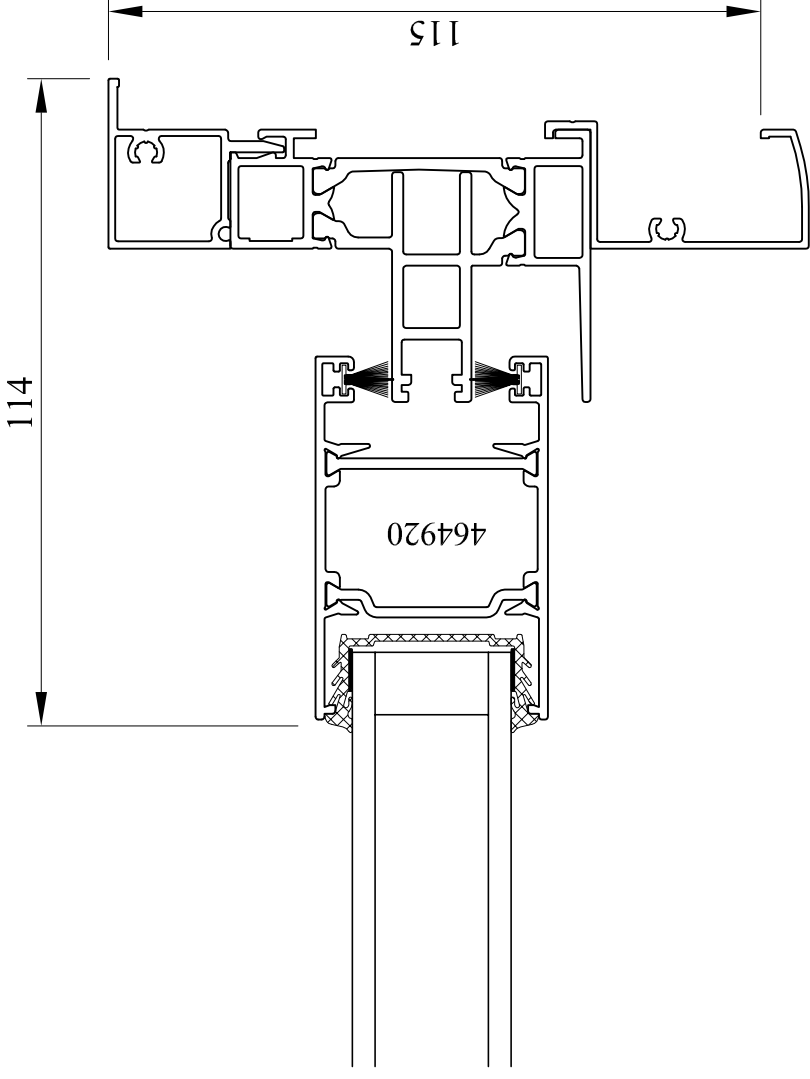
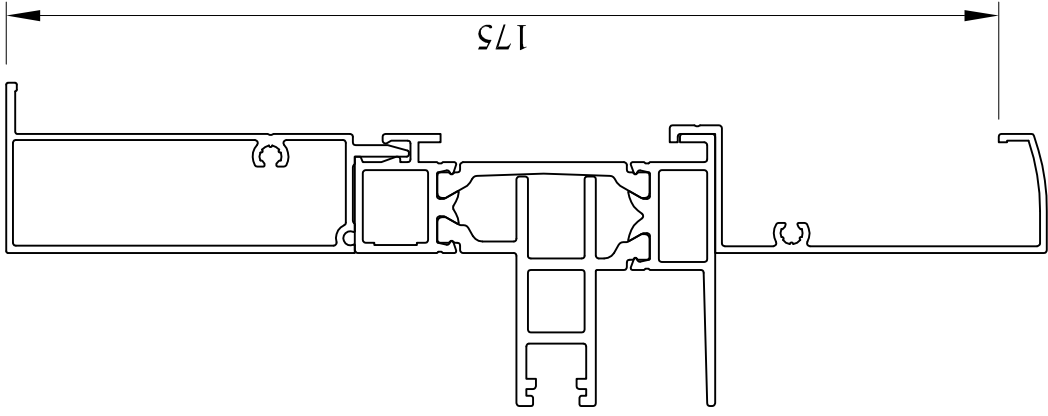

Emplacement :

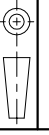

Echelle : 3/4

Date : 19/07/2017

Des. : PC

N° plan : DT-A15GA-D19

CE DOCUMENT EST LA PROPRIETE DES MENISERIES ELVA. IL NE PEUT ETRE REPRODUIT OU COMMUNIQUE SANS SON AUTORISATION

Incl. 0

Masse rive droite dormant 1 rail de 114 mm (vitrage de 28 mm)

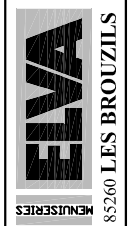
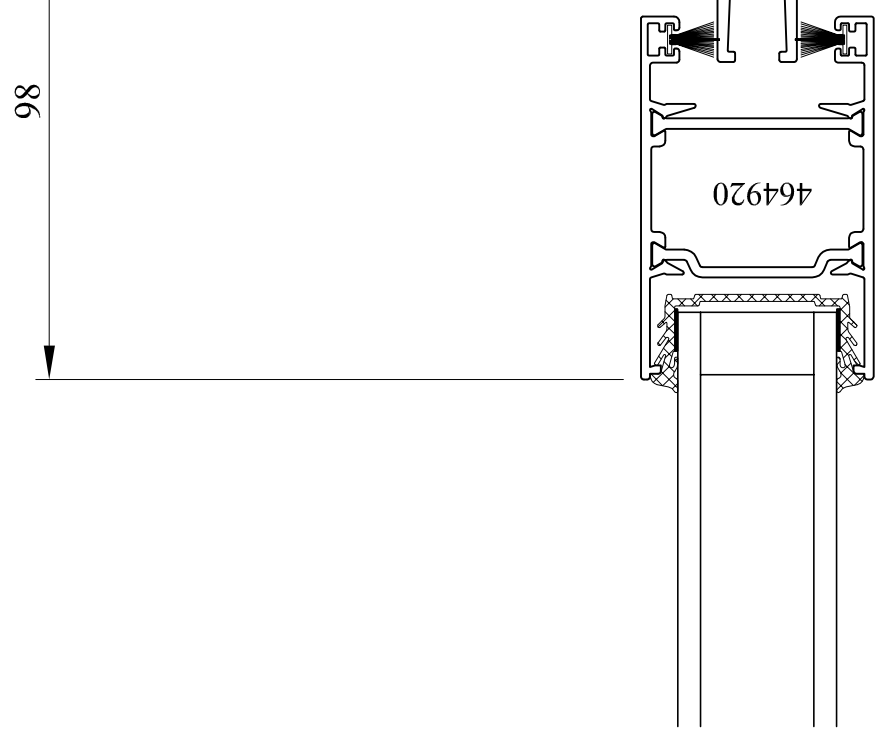
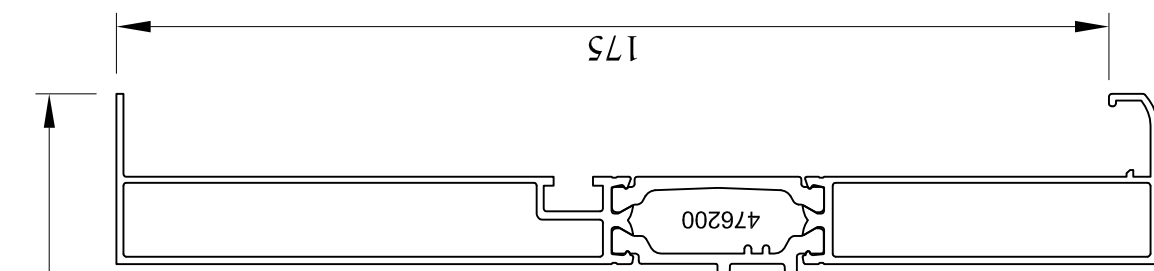
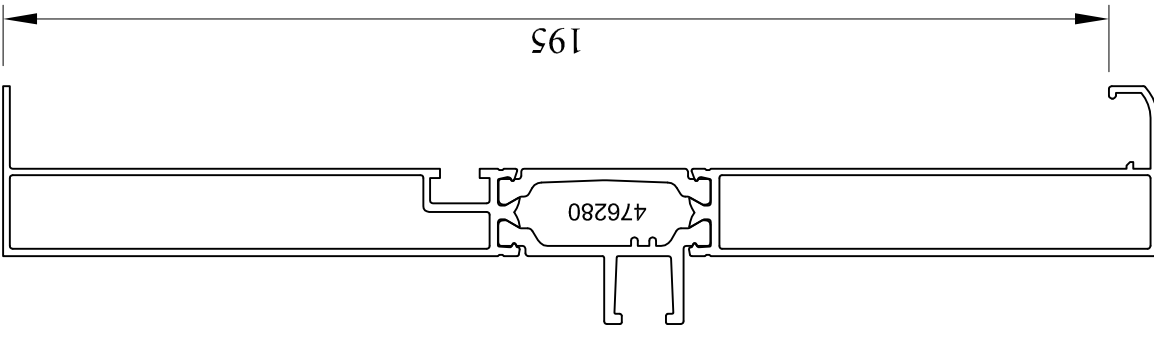

Emplacement :



Echelle : 3/4

Date : 19/07/2017

Des. : PC

N° plan : DT-A15GA-D20

CE DOCUMENT EST LA PROPRIETE DES MENUISERIES ELVA. IL NE PEUT ETRE REPRODUIT OU COMMUNIQUE SANS SON AUTORISATION

Incl. 0

Masse rive droite dormant 2 rails de 98 mm (vitrage de 28 mm)

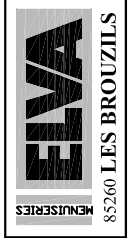
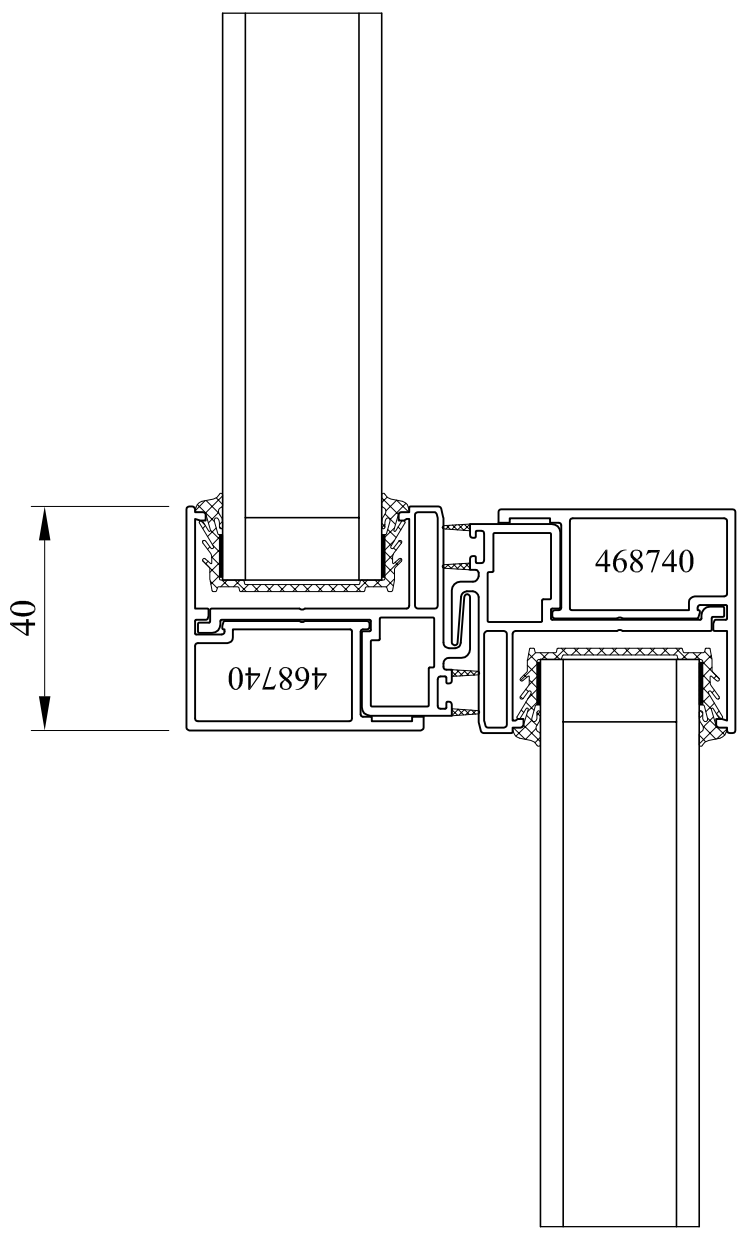

Emplacement :



Echelle : 3/4

Date : 19/07/2016

Des. : PC

N° plan : DT-A15GA-D4

CE DOCUMENT EST LA PROPRIETE DES MENISERIES ELVA. IL NE PEUT ETRE REPRODUIT OU COMMUNIQUE SANS SON AUTORISATION

Incl. 0

Masse centrale de 40 mm (vitrage de 28 mm)





# PLANS D'ENSEMBLE

Menuiseries : ALUMINIUM

Gamme : GALANDAGE

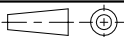
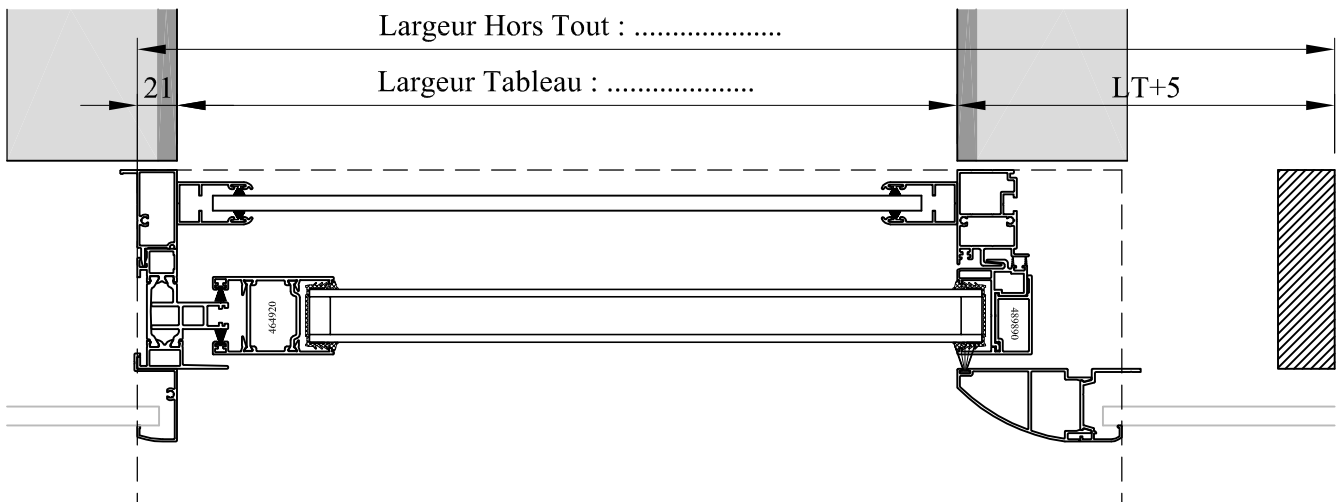
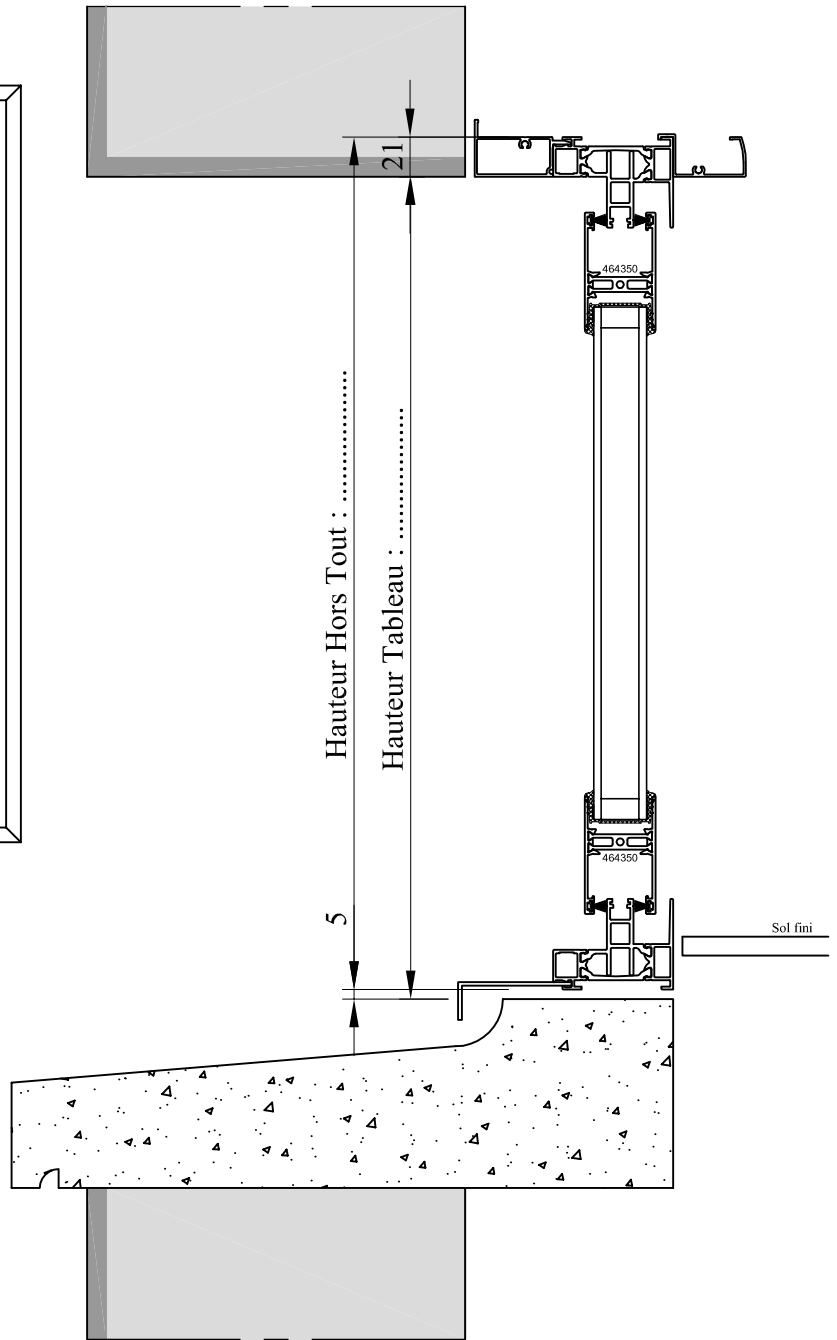
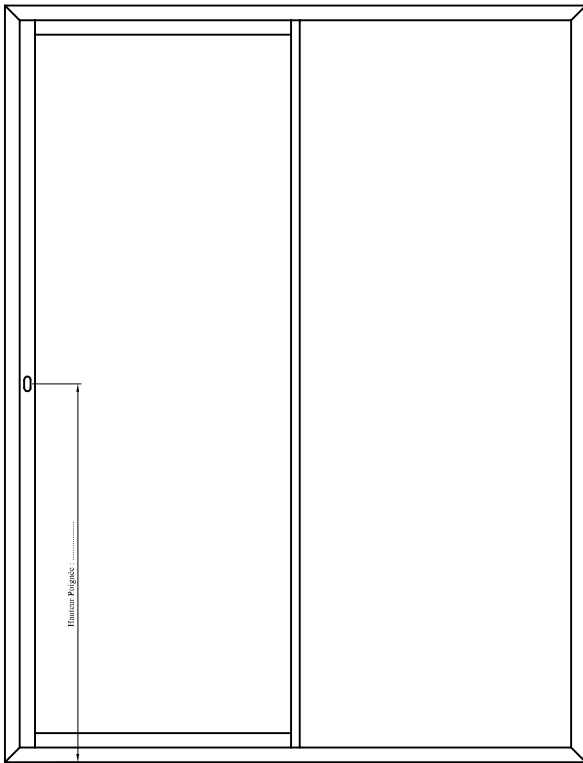

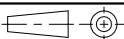
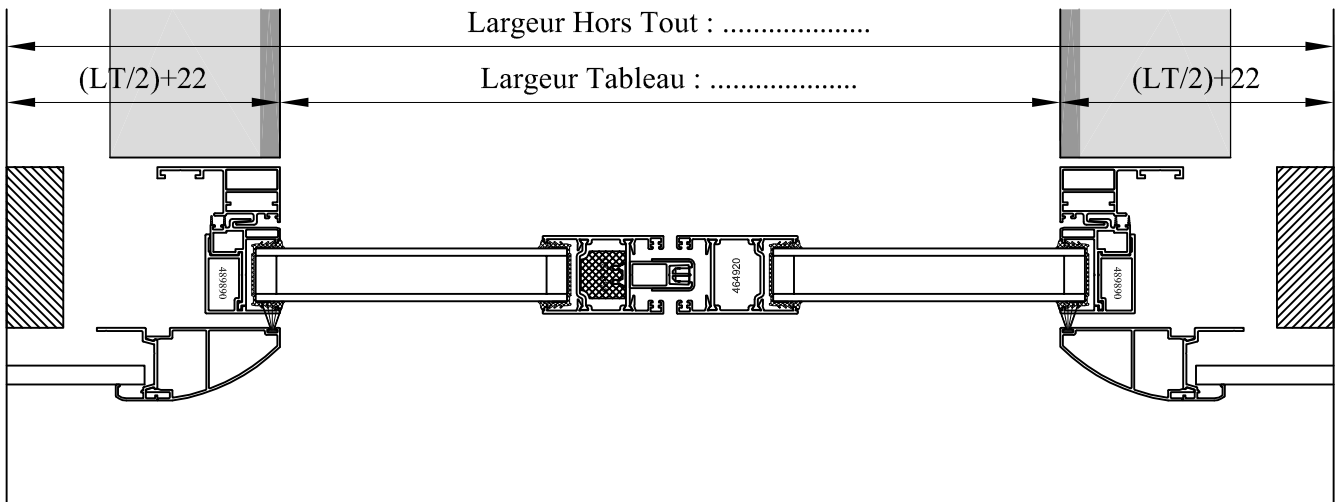
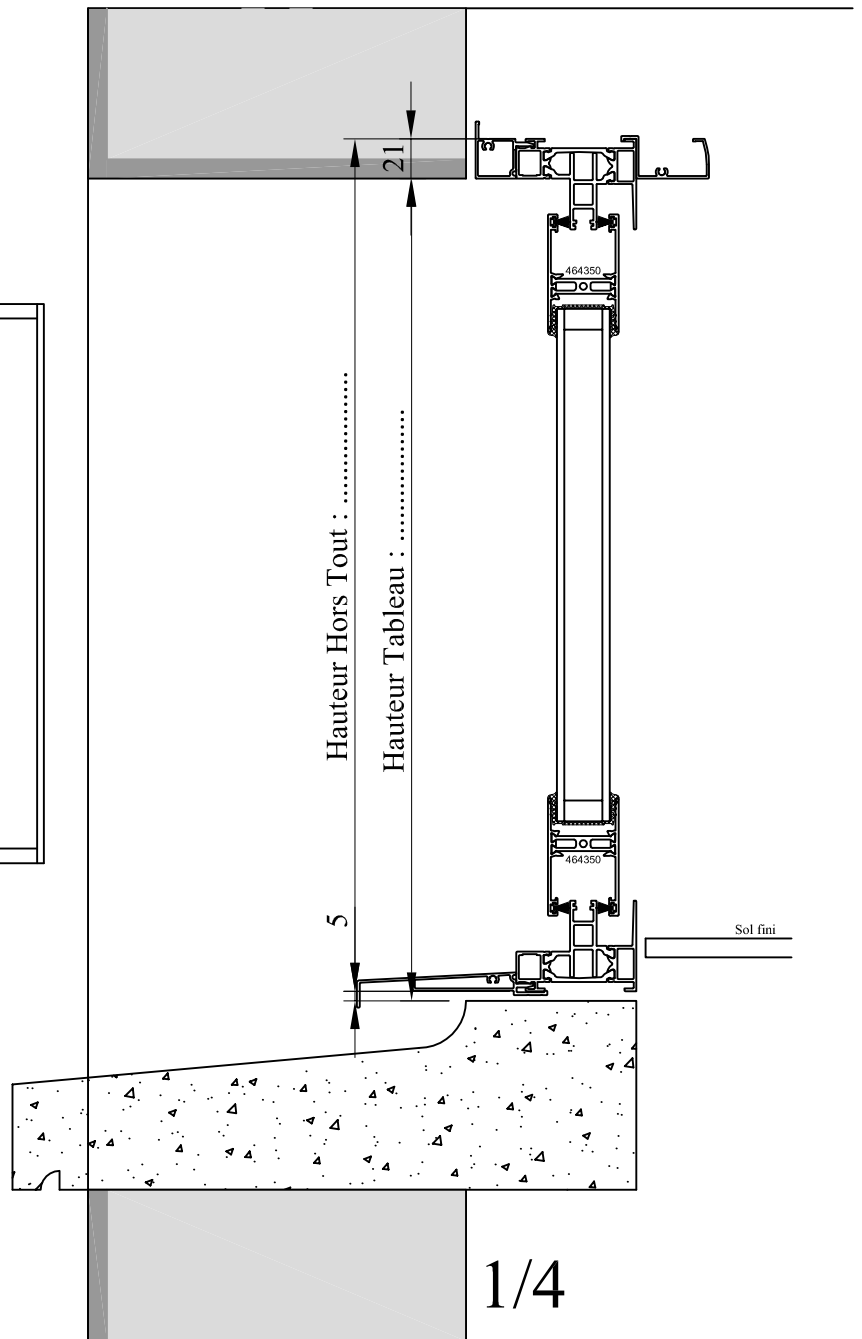
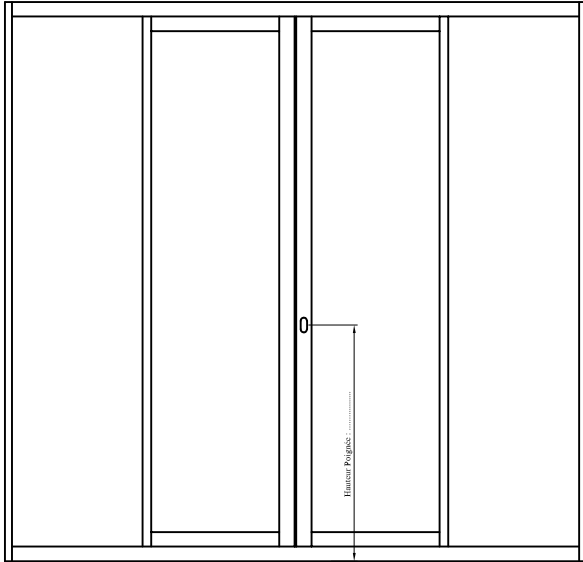

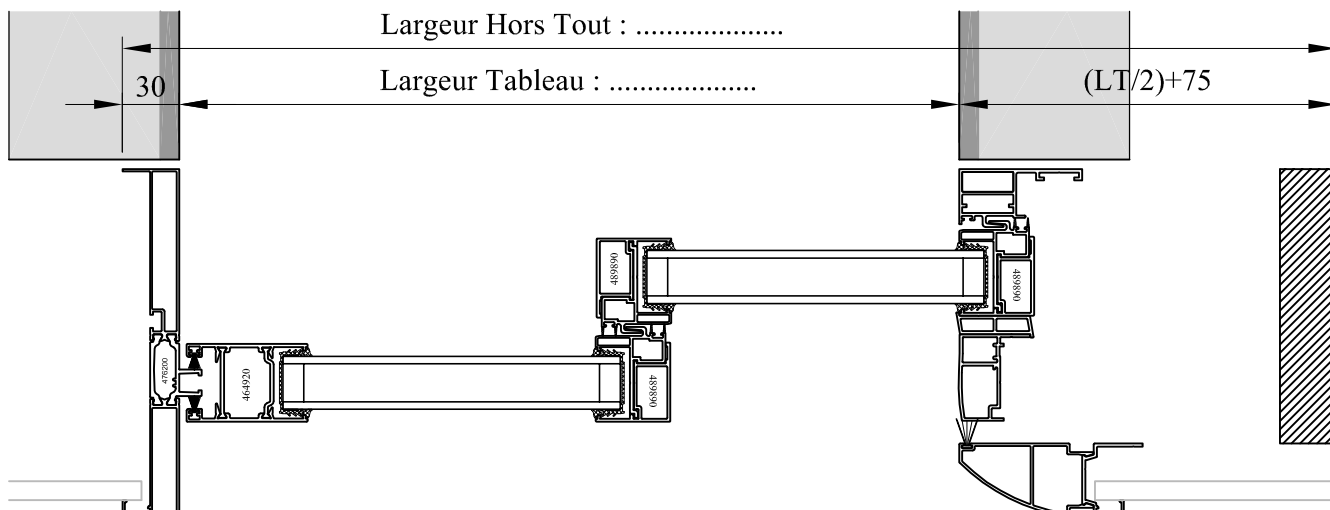
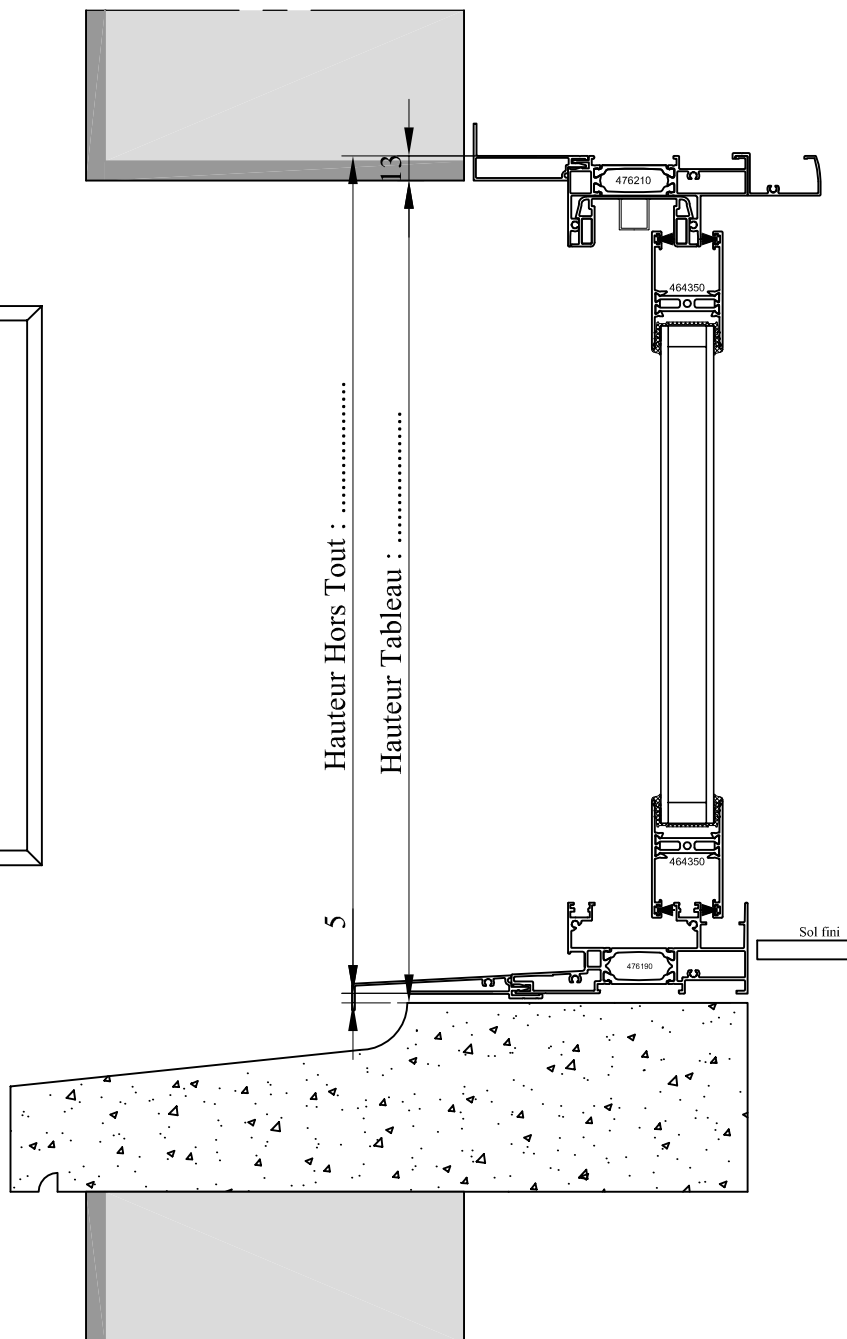
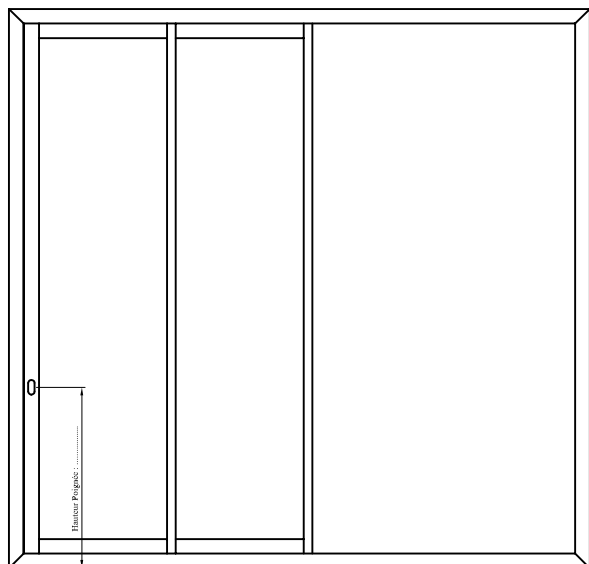



# REMPLISSAGES

Menuiseries : ALUMINIUM

Gamme : GALANDAGE

# Remplissage de 24 / 28 / 30 mm

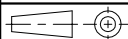
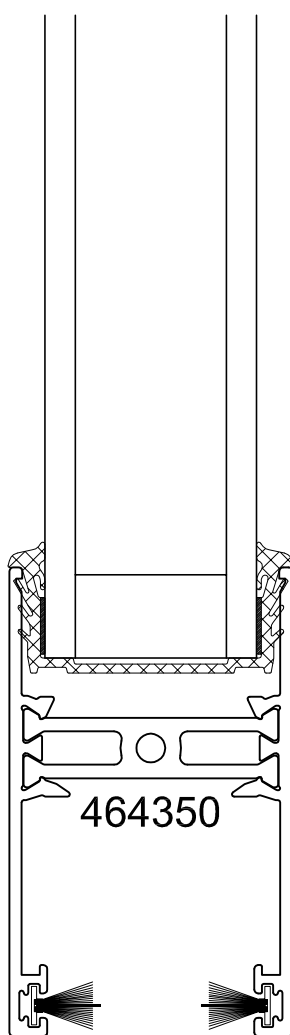









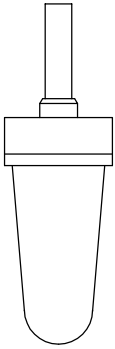

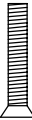
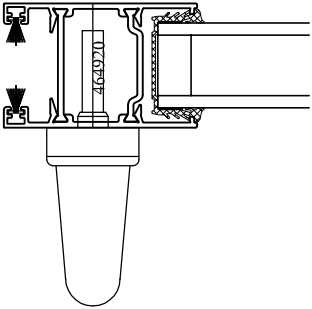
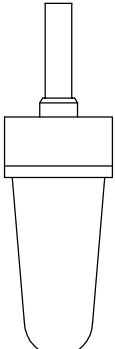
# QUINCAILLERIES

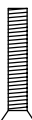
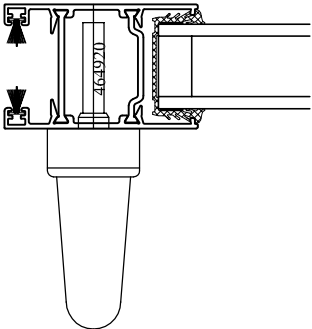
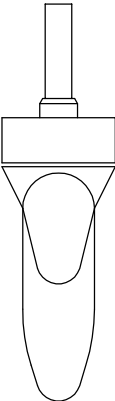
Menuiseries : ALUMINIUM

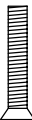
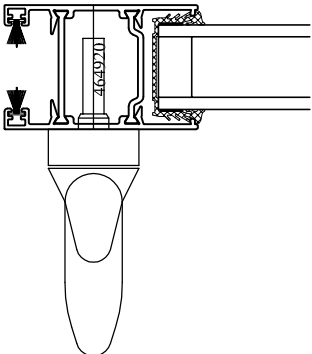
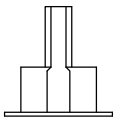
Gamme : GALANDAGE

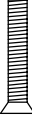
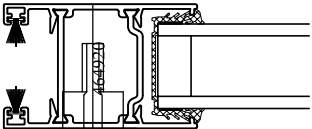
<b>Poignées Standard</b>		 <b>7 mm</b> <b>Longueur : 32 mm</b>  <b>Longueur : 40 mm</b>	<b>Fouillot de 15 mm</b> 
		 <b>7 mm</b> <b>Longueur : 32 mm</b>  <b>Longueur : 40 mm</b>	<b>Fouillot de 15 mm</b> 
<b>Poignées Tirage</b>		 <b>7 mm</b> <b>Longueur : 30 mm</b>  <b>Longueur : 40 mm</b>	<b>Fouillot de 15 mm</b> 
		 <b>7 mm</b> <b>Longueur : 30 mm</b>  <b>Longueur : 20 mm</b>	<b>Fouillot de 15 mm</b> 





MENUISERIES

**ELVA**

# PATTES DE FIXATION

Menuiseries : ALUMINIUM

Gamme : GALANDAGE

Iso. Dormant	Fixation		
120	P41000083 (83)	-----	P41000083 (83)
140	P41000118 (118)	P41000043 (43)	P41000083 (83)
160	P41000118 (118)	P41000043 (43)	P41000083 (83)
180	P41000118 (118)	P41000068 (68)	P41000083 (83)

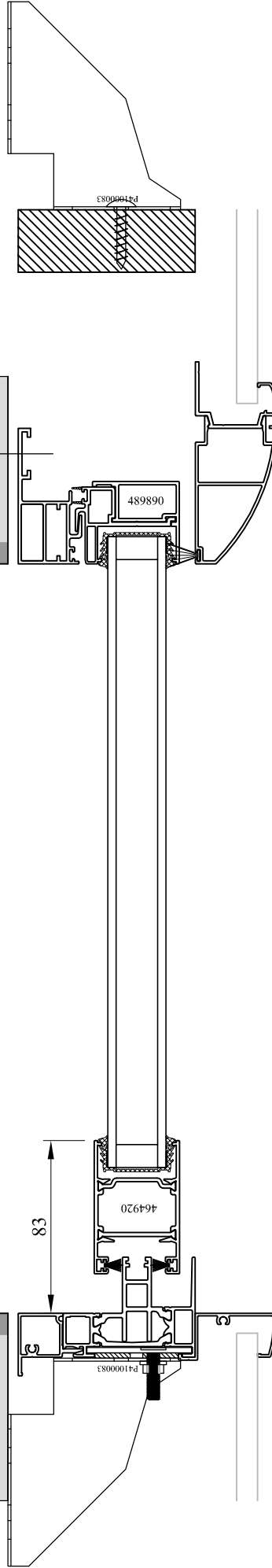

Iso. Dormant	Fixation		
120	P41000083 (83)	-----	P41000083 (83)
140	P41000118 (118)	P41000043 (43)	P41000083 (83)
160	P41000118 (118)	P41000043 (43)	P41000083 (83)
180	P41000118 (118)	P41000068 (68)	P41000083 (83)

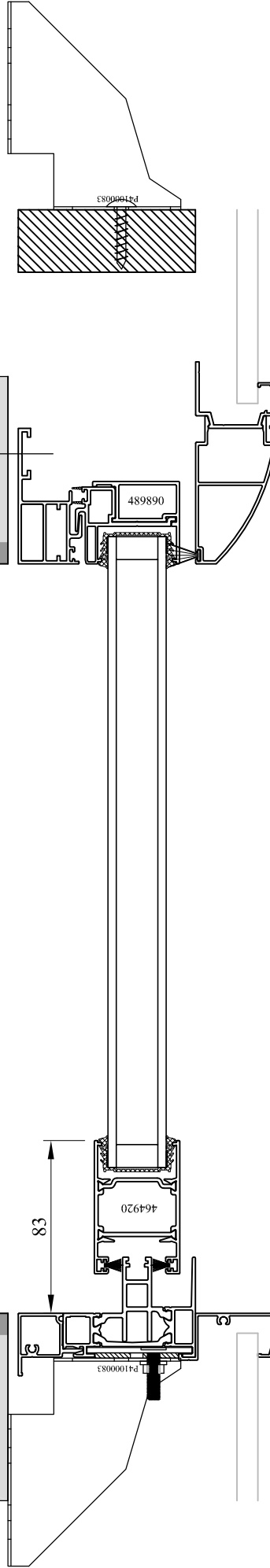

Iso. Dormant	Fixation		
140	P41000118 (118)	P41000043 (43)	P41000083 (83)
160	P41000118 (118)	P41000043 (43)	P41000083 (83)
180	P41000118 (118)	P41000068 (68)	P41000083 (83)

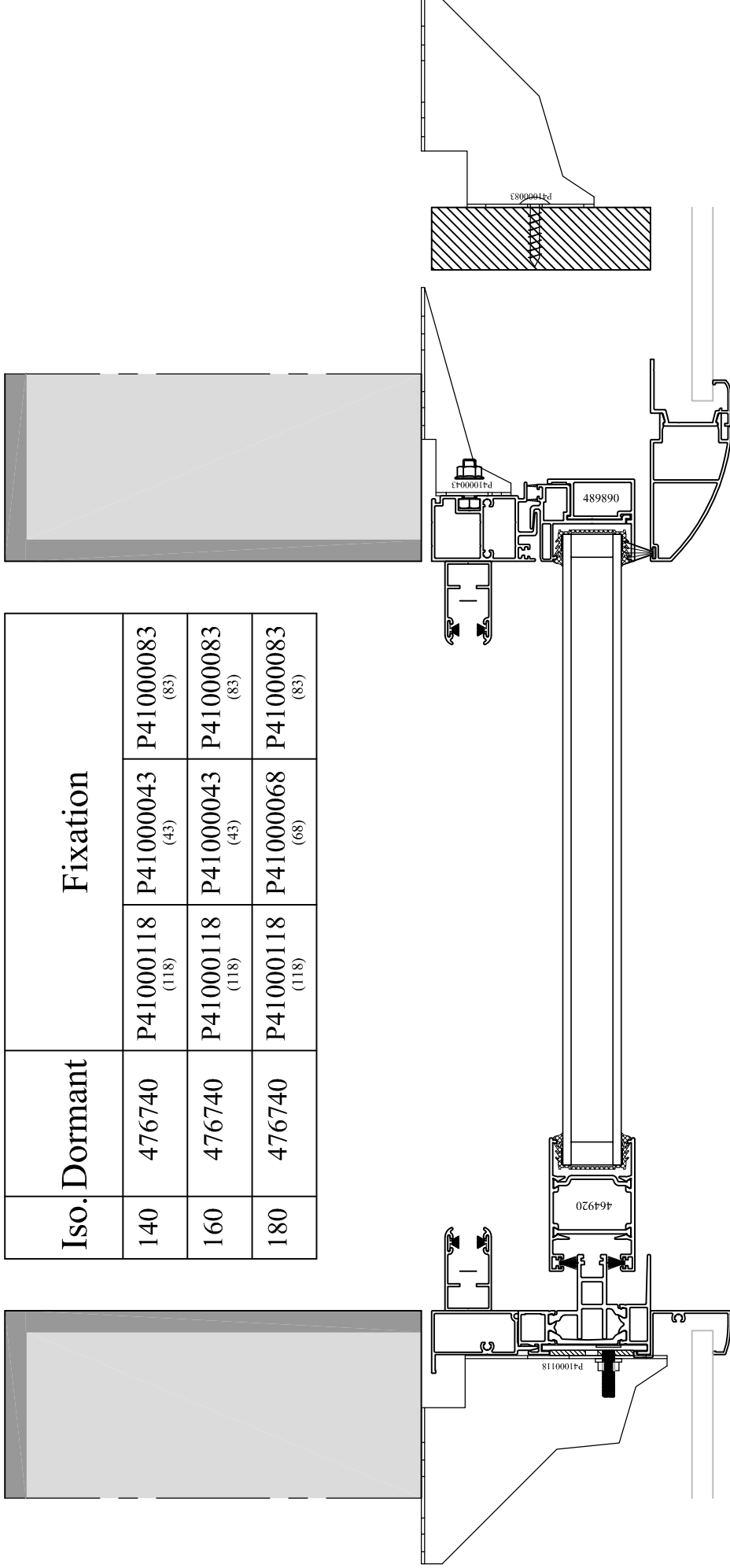

Emplacement :



Echelle : 7/20

Date : 19/07/2017

Des. : PC

N° plan : DT-A15GA-F3

CE DOCUMENT EST LA PROPRIETE DES MENUISERIES ELVA. IL NE PEUT ETRE REPRODUIT OU COMMUNIQUE SANS SON AUTORISATION

Incl. 0

Fixation suivant isolation --- Menuiseries ALUMINIUM GALANDAGE

Iso. Dormant	Fixation			
140	476740	P41000118 (118)	P41000043 (43)	P41000083 (83)
160	476740	P41000118 (118)	P41000043 (43)	P41000083 (83)
180	476740	P41000118 (118)	P41000068 (68)	P41000083 (83)

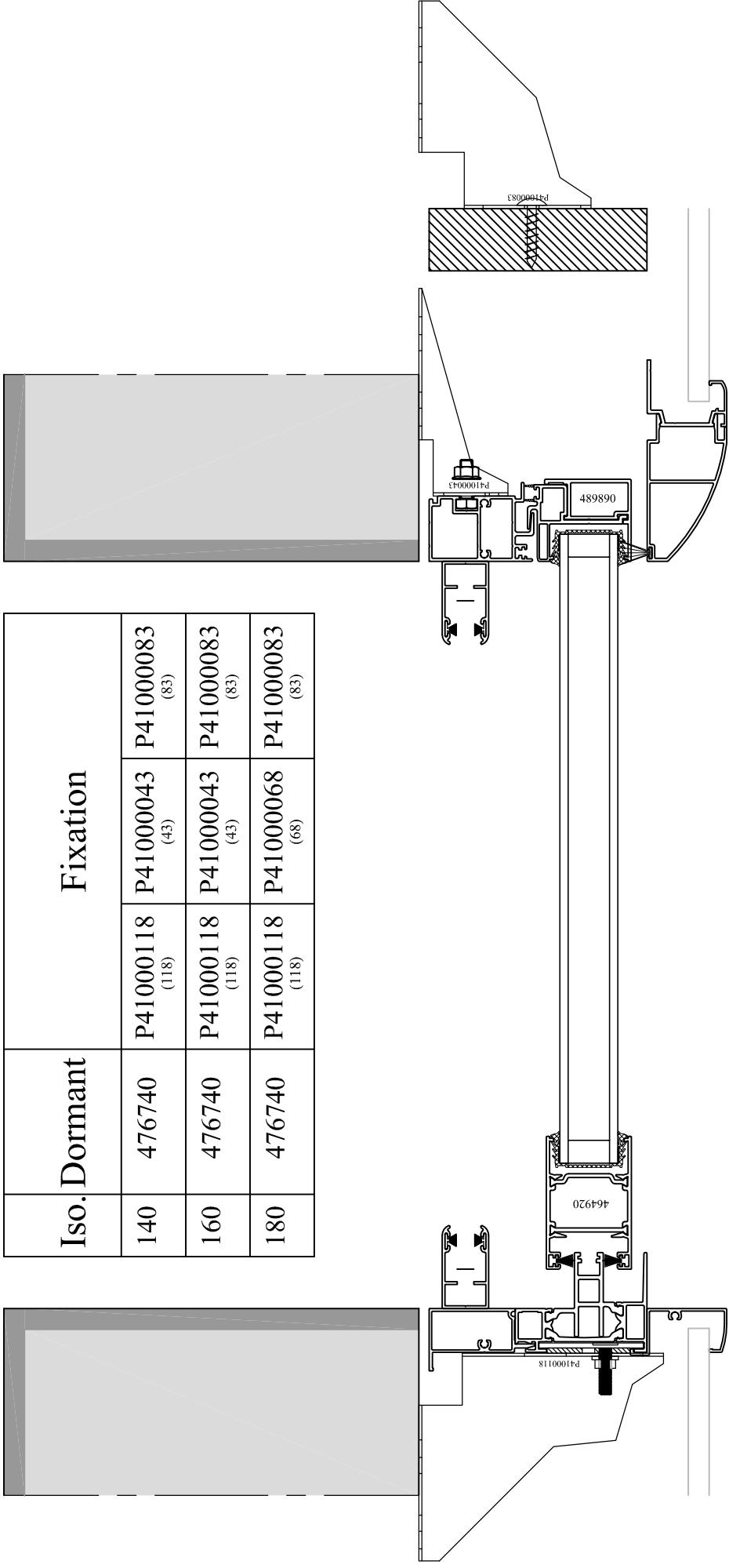

Emplacement :



Echelle : 7/20

Date : 19/07/2017

Des. : PC

N° plan : DT-A15GA-F4

CE DOCUMENT EST LA PROPRIETE DES MENUSIERES ELVA. IL NE PEUT ETRE REPRODUIT OU COMMUNIQUE SANS SON AUTORISATION

Incl. 0

Fixation suivant isolation --- Me nuiseries ALUMINIUM GALANDAGE



**POSITION**

**PIECE D'APPUI BETON**

Menuiseries : ALUMINIUM

Gamme : GALANDAGE

# RESERVATION MAÇONNERIE

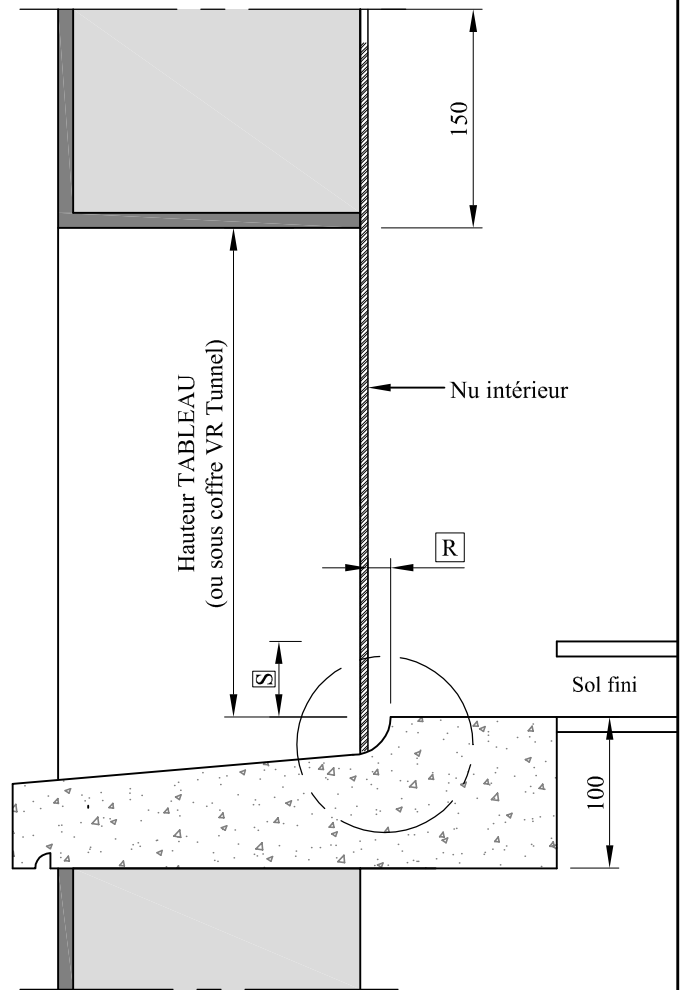
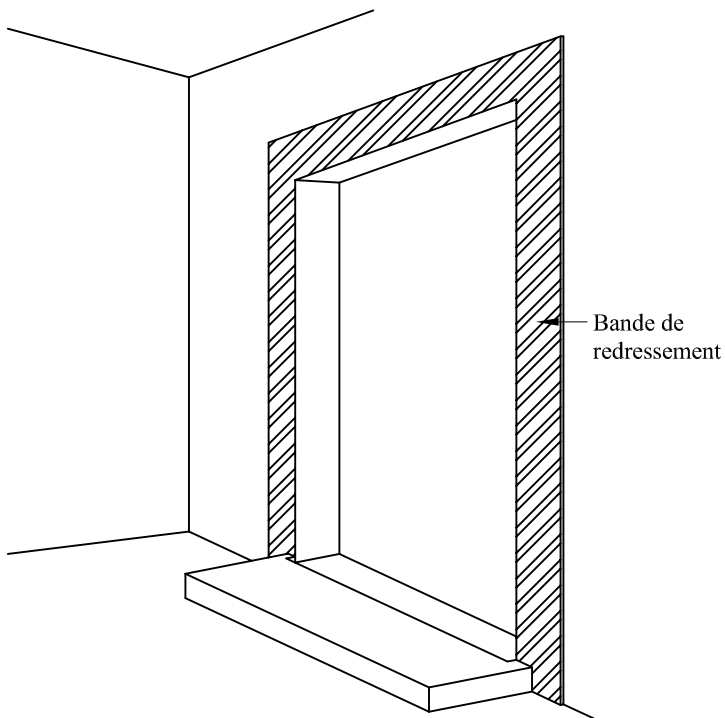

Couissants à galandage 1 Rail										
Isolation	120		140		160		180			
R	0		20		20		40			
Encastrement du seuil	Standard				NON					
S	33				0					

Extérieur

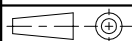
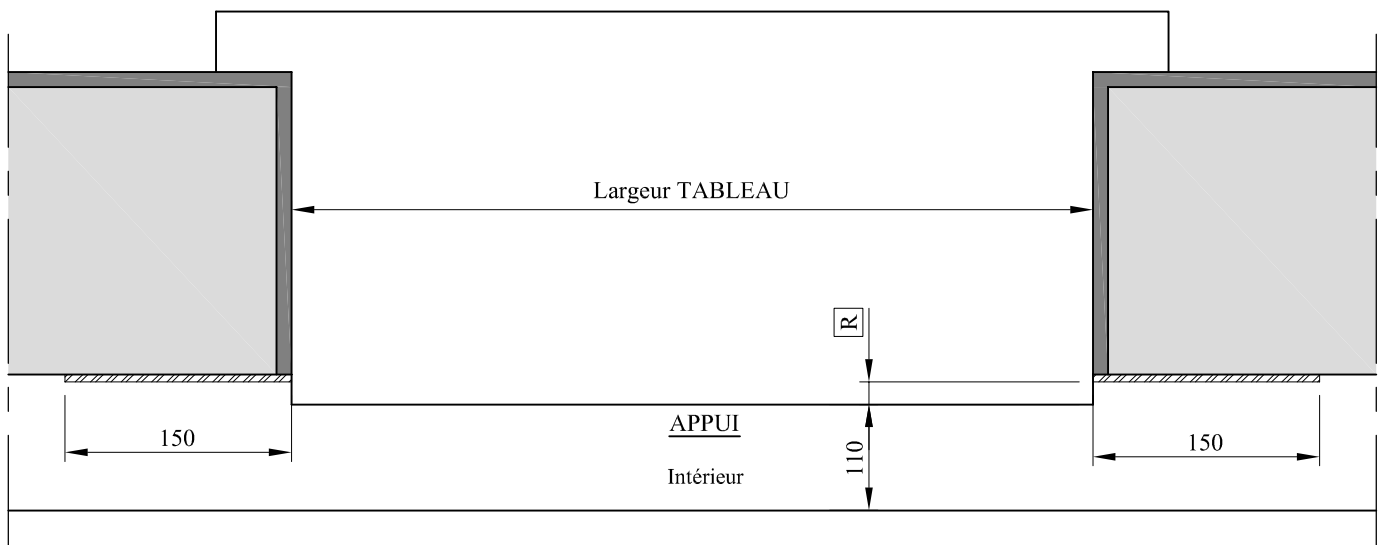

# RESERVATION MAÇONNERIE

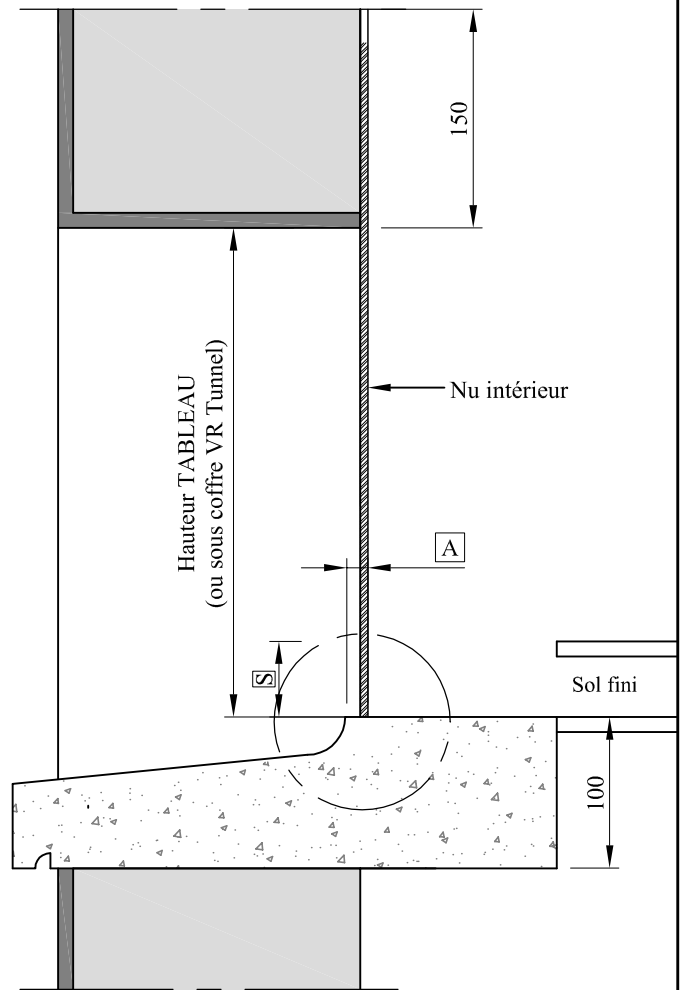
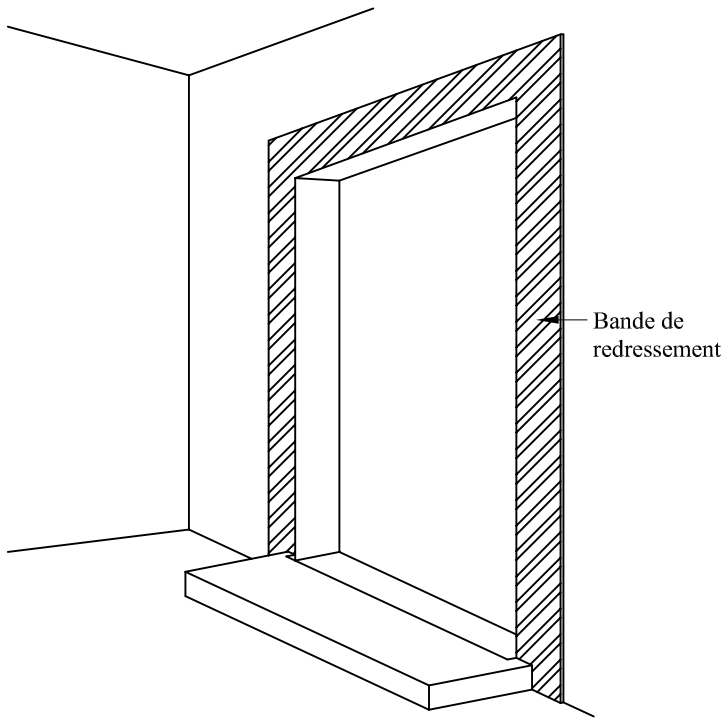

Coulissants à galandage 1 Rail									
Isolation							180		200
A							30		30
Encastrement du seuil	Standard				NON				
S	33				0				

Extérieur

